

Please check the examination details below before entering your candidate information

Candidate surname

Other names

Centre Number

Candidate Number

Pearson Edexcel
Level 1/Level 2 GCSE (9–1)

--	--	--	--	--

--	--	--	--	--

Monday 9 November 2020

Morning (Time: 1 hour 30 minutes)

Paper Reference **1MA1/3H**

Mathematics
Paper 3 (Calculator)
Higher Tier



You must have: Ruler graduated in centimetres and millimetres, protractor, pair of compasses, pen, HB pencil, eraser, calculator. Tracing paper may be used.

Total Marks

Instructions

- Use **black** ink or ball-point pen.
- **Fill in the boxes** at the top of this page with your name, centre number and candidate number.
- Answer **all** questions.
- Answer the questions in the spaces provided – *there may be more space than you need.*
- You must **show all your working.**
- Diagrams are **NOT** accurately drawn, unless otherwise indicated.
- **Calculators may be used.**
- If your calculator does not have a π button, take the value of π to be 3.142 unless the question instructs otherwise.



Information

- The total mark for this paper is 80
- The marks for **each** question are shown in brackets – *use this as a guide as to how much time to spend on each question.*

Advice

- Read each question carefully before you start to answer it.
- Keep an eye on the time.
- Try to answer every question.
- Check your answers if you have time at the end.

Turn over ►

P62279A

©2020 Pearson Education Ltd.

1/1/1/



Pearson

Answer ALL questions.

Write your answers in the spaces provided.

You must write down all the stages in your working.

1 (a) Simplify $n^3 \times n^5$

n^8

(1)

(b) Simplify $\frac{c^3d^4}{c^2d}$

c^1d^3

(2)

(c) Solve $\frac{5x}{2} > 7$

$5x > 14$
 $x > \frac{14}{5}$

$x > \frac{14}{5}$

(2)

(Total for Question 1 is 5 marks)

DO NOT WRITE IN THIS AREA

DO NOT WRITE IN THIS AREA

DO NOT WRITE IN THIS AREA



- 2 Andy cycles a distance of 30 km at an average speed of 24 km/h.
He then runs a distance of 12 km at an average speed of 8 km/h.

Work out the total time Andy takes.
Give your answer in hours and minutes.

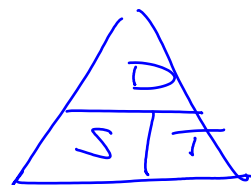

$$T = \frac{30}{24} = 1.25 \text{ hours}$$

$$T = \frac{12}{8} = 1.5 \text{ hours}$$

$$\text{Total} = 2.75 \text{ hours}$$

..... 2 hours 45 minutes

(Total for Question 2 is 3 marks)

- 3 A number, m , is rounded to 1 decimal place.
The result is 9.4

Complete the error interval for m .

$$\text{..... } 9.35 \leq m < 9.45 \text{}$$

(Total for Question 3 is 2 marks)



- 4 Maisie knows that she needs 3 kg of grass seed to make a rectangular lawn 5 m by 9 m.

Grass seed is sold in 2 kg boxes.

Maisie wants to make a rectangular lawn 10 m by 14 m.

She has 5 boxes of grass seed.

- (a) Has Maisie got enough grass seed to make a lawn 10 m by 14 m?

You must show all your working.

$$\begin{array}{r}
 9 \times 5 = 45 \text{ m}^2 \\
 10 \times 14 = 140 \text{ m}^2
 \end{array}
 \left. \begin{array}{l} \\ \\ \end{array} \right\} \times \frac{28}{9}
 \begin{array}{l}
 \text{with } 3 \text{ kg} \\
 \times \frac{28}{9} \\
 \hline
 28 \text{ kg}
 \end{array}
 = 9 \frac{1}{3} \text{ kg}$$

need $5 \times 2 = 10 \text{ kg}$
5 boxes

Yes, she has enough boxes.

(4)

Maisie opens the 5 boxes of grass seed.

She finds that 4 of the boxes contain 2 kg of grass seed.

The other box contains 1 kg of grass seed.

- (b) Does this affect whether Maisie has enough grass seed to make her lawn?

Give a reason for your answer.

Yes. She has 9 kg, but she needs $9 \frac{1}{3}$ kg, so doesn't have enough.

(1)

(Total for Question 4 is 5 marks)



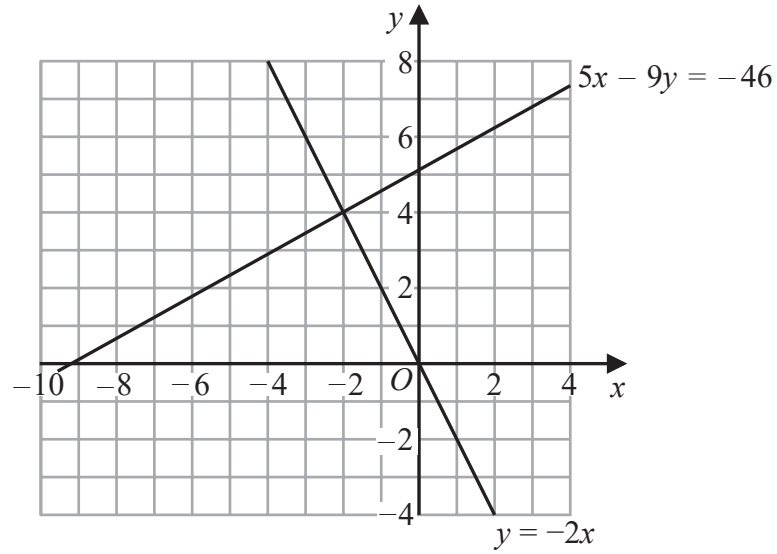

(a) Use these graphs to solve the simultaneous equations

$$\begin{aligned} 5x - 9y &= -46 \\ y &= -2x \end{aligned}$$

$$\begin{aligned} x &= \dots - 2 \dots \\ y &= \dots 4 \dots \\ &\quad (1) \end{aligned}$$



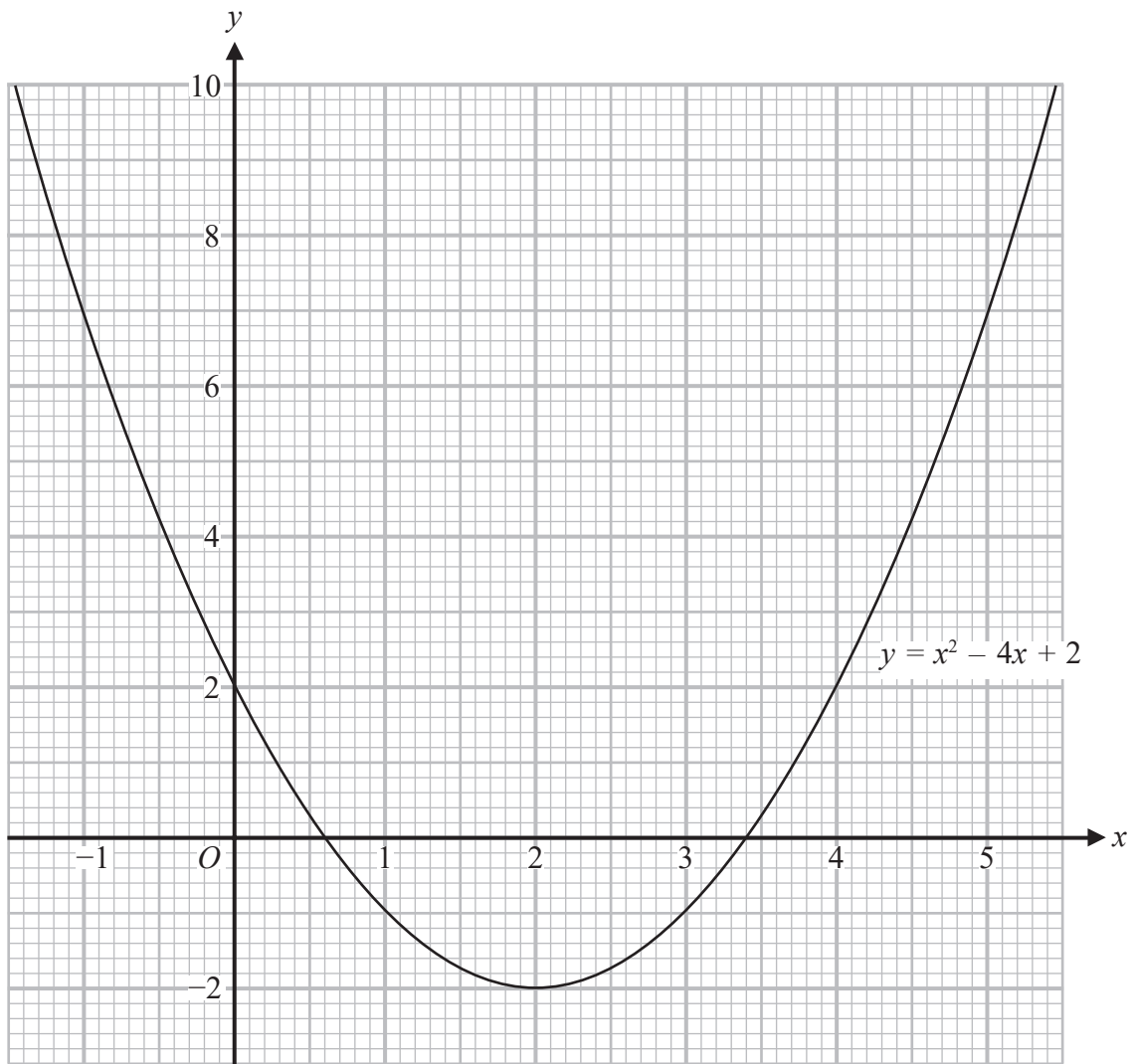

(b) Use this graph to find estimates for the solutions of the quadratic equation $x^2 - 4x + 2 = 0$

$x = 0.6, x = 3.4$
(2)

(Total for Question 6 is 3 marks)

DO NOT WRITE IN THIS AREA



7 There is a total of 45 boys and girls in a choir.

The mean age of the 18 boys is 16.2 years.

The mean age of the 27 girls is 16.7 years.

Calculate the mean age of all 45 boys and girls.

$$\begin{array}{r} \text{boys} \quad 18 \times 16.2 = 291.6 \\ \text{girls} \quad 27 \times 16.7 = 450.9 \\ \hline 742.5 \end{array}$$

$$\text{mean} = \frac{742.5}{45} = 16.5$$

..... 16.5 years

(Total for Question 7 is 3 marks)



DO NOT WRITE IN THIS AREA

8 There are some counters in a bag.
The counters are blue or green or red or yellow.

The table shows the probabilities that a counter taken at random from the bag will be blue or will be green.

Colour	blue	green	red	yellow
Probability	0.32	0.20	$\frac{5}{6}$	x

The probability that a counter taken at random from the bag will be red is five times the probability that the counter will be yellow.

There are 300 counters in the bag.

Work out the number of yellow counters in the bag.

$$\frac{5}{6} + 0.32 = 1$$

$$x = \frac{1 - 0.32}{6} = 0.08$$

$$0.08 \times 300 = 24$$

24

(Total for Question 8 is 3 marks)



9 The diagram shows a prism.

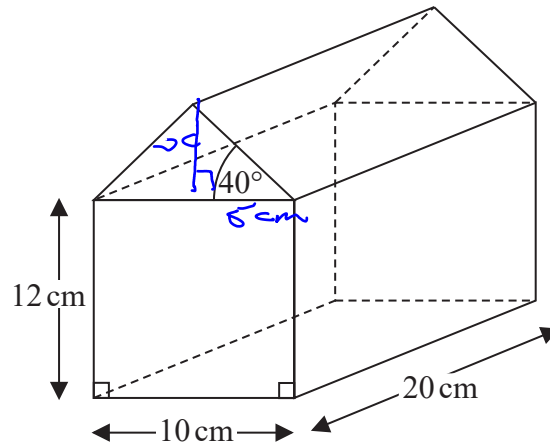

The cross section of the prism has exactly one line of symmetry.

Work out the volume of the prism.

Give your answer correct to 3 significant figures.

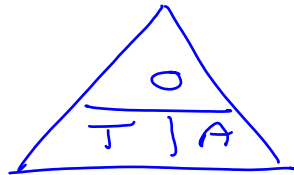
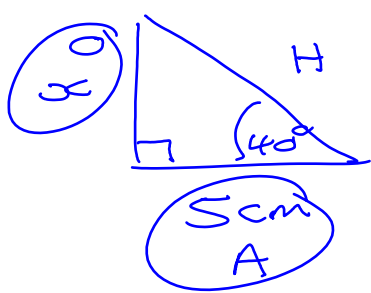

$$x = \tan(40) \times 5$$

$$x = 4.195498156 \text{ cm}$$

$$\text{Area of triangle} = \frac{1}{2} \times 10 \times 4.195498156$$

$$= 20.97749078 \text{ cm}^2$$

$$\text{Area of rectangle} = 12 \times 10 = 120 \text{ cm}^2$$

$$\text{Area of cross section} = 120 + 20.97749078$$

$$= 140.97749078 \text{ cm}^2$$

$$\text{Volume} = 140.97749078 \times 20$$

$$= 2819.549816 \text{ cm}^3$$

$$\underline{2820} \text{ cm}^3$$

(3sf)

(Total for Question 9 is 5 marks)

DO NOT WRITE IN THIS AREA

DO NOT WRITE IN THIS AREA

DO NOT WRITE IN THIS AREA



DO NOT WRITE IN THIS AREA

DO NOT WRITE IN THIS AREA

DO NOT WRITE IN THIS AREA

10 A person's heart beats approximately 10^5 times each day.
A person lives for approximately 81 years.

- (a) Work out an estimate for the number of times a person's heart beats in their lifetime.
Give your answer in standard form correct to 2 significant figures.

$$\begin{aligned}
 &10^5 \times 365 \times 81 \\
 &= 2956,500,000 \\
 &= 3,000,000,000
 \end{aligned}$$

$$\begin{aligned}
 &3.0 \times 10^9 \\
 &\text{(2sf)} \quad (2)
 \end{aligned}$$

2×10^{12} red blood cells have a total mass of 90 grams.

- (b) Work out the average mass of 1 red blood cell.
Give your answer in standard form.

$$\begin{aligned}
 &90 \div 2 \times 10^{12} \\
 &= 4.5 \times 10^{-11}
 \end{aligned}$$

$$\begin{aligned}
 &4.5 \times 10^{-11} \text{ grams} \\
 &\quad (2)
 \end{aligned}$$

(Total for Question 10 is 4 marks)



11 The diagram shows a triangle **P** on a grid.

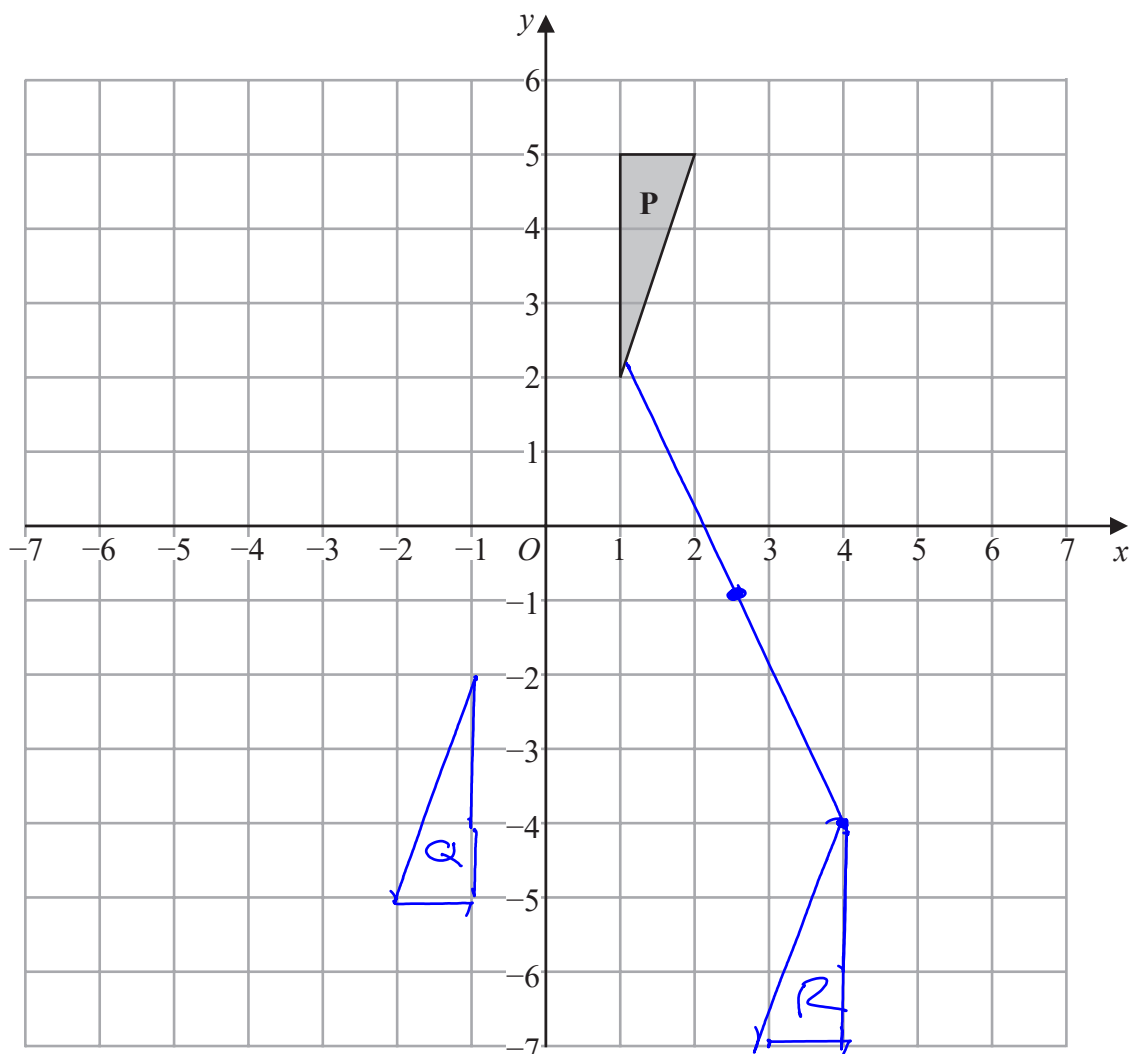

Triangle **P** is rotated 180° about $(0, 0)$ to give triangle **Q**.

Triangle **Q** is translated by $\begin{pmatrix} 5 \\ -2 \end{pmatrix}$ to give triangle **R**.

(a) Describe fully the single transformation that maps triangle **P** onto triangle **R**.

Rotation 180° about $(2.5, -1)$

(3)

Under the transformation that maps triangle **P** onto triangle **R**, the point *A* is invariant.

(b) Write down the coordinates of point *A*.

$(2.5, -1)$

(1)

(Total for Question 11 is 4 marks)



12 (a) Express $\frac{x}{x+2} + \frac{2x}{x-4}$ as a single fraction in its simplest form.

$$\begin{aligned} & \frac{x(x-4) + 2x(x+2)}{(x+2)(x-4)} \\ &= \frac{x^2 - 4x + 2x^2 + 4x}{(x+2)(x-4)} \\ &= \frac{3x^2}{(x+2)(x-4)} \end{aligned}$$

(3)

(b) Expand and simplify $(x-3)(2x+3)(4x+5)$

$$\begin{aligned} & (x-3)(8x^2 + 10x + 12x + 15) \\ &= (x-3)(8x^2 + 22x + 15) \\ &= 8x^3 + 22x^2 + 15x \\ & \quad - 24x^2 - 66x - 45 \\ &= 8x^3 - 2x^2 - 51x - 45 \end{aligned}$$

$$8x^3 - 2x^2 - 51x - 45$$

(3)

(Total for Question 12 is 6 marks)



13 (a) On the grid show, by shading, the region that satisfies all these inequalities.

$$x \geq 0 \quad x \leq 2 \quad y \leq x + 3 \quad 2x + 3y \geq 6$$

Label the region **R**.

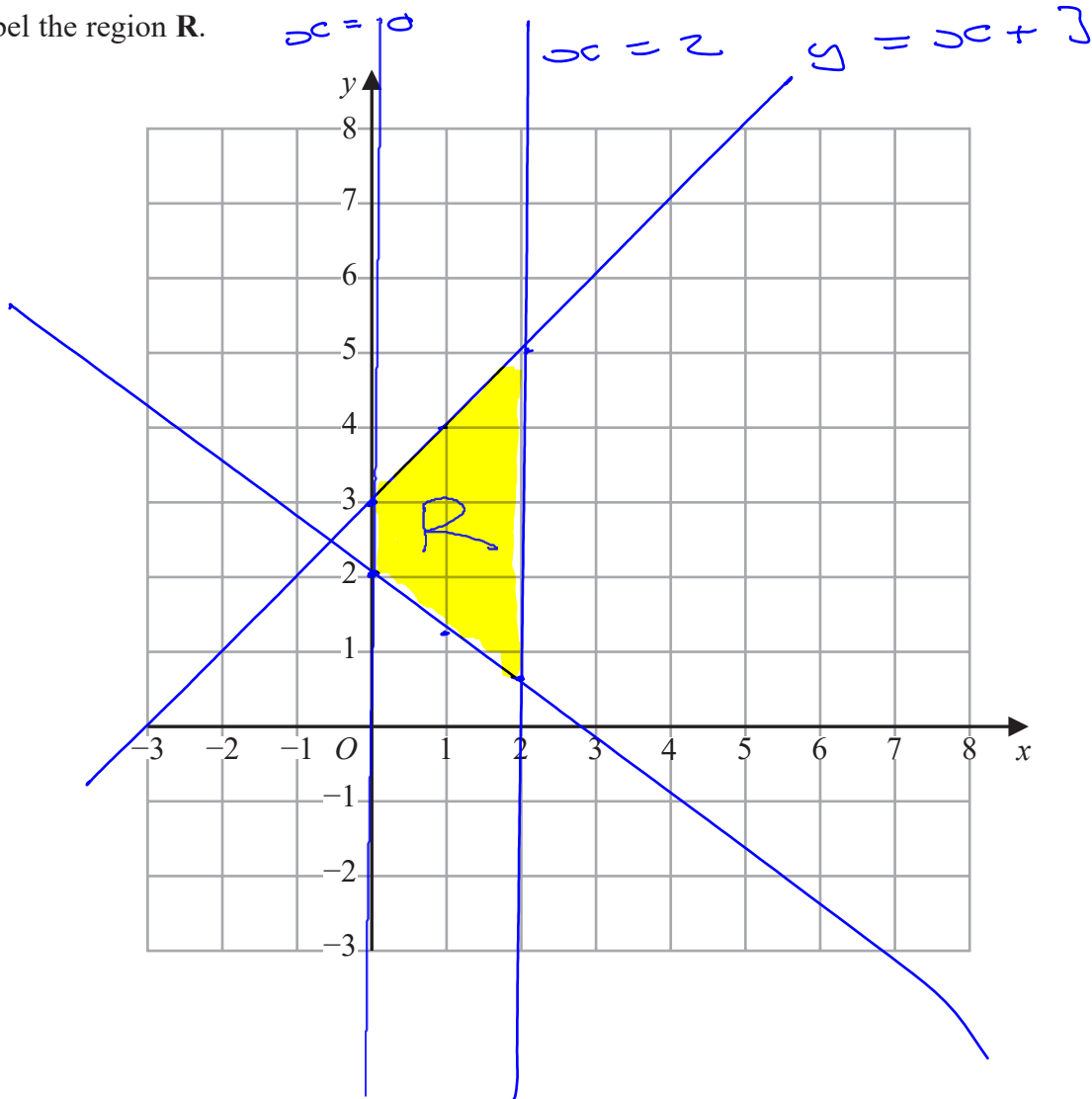

(4)

x	0	1	2
$y = x + 3$	3	4	5

$$3y = -2x + 6$$

$$y = -\frac{2}{3}x + 2$$

x	0	1	2
$y = -\frac{2}{3}x + 2$	2	$\frac{4}{3}$	$\frac{2}{3}$



(b) The diagram below shows the region S that satisfies the inequalities

$$y \leq 4x \quad y \geq \frac{1}{2}x \quad x + y \leq 6$$

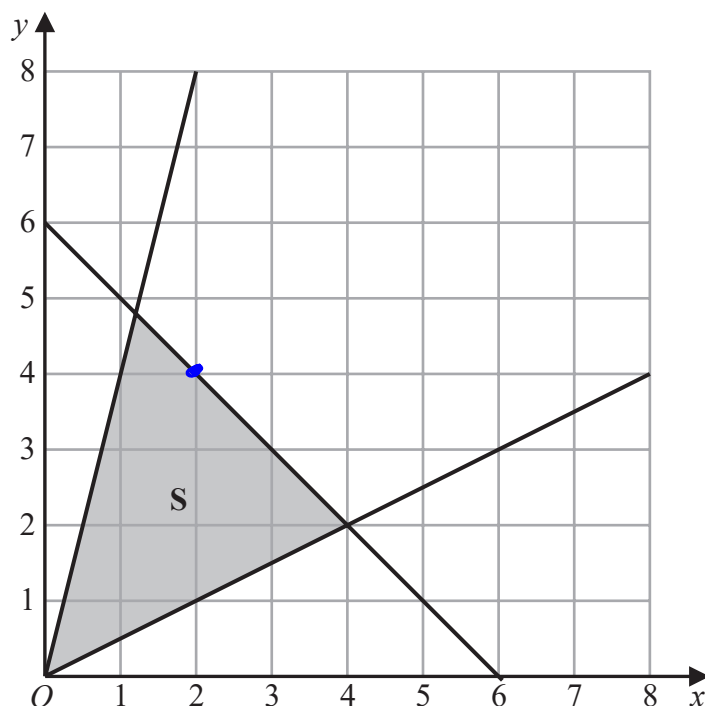

Geoffrey says that the point with coordinates (2, 4) does not satisfy all the inequalities because it does not lie in the shaded region.

Is Geoffrey correct?

You must give a reason for your answer.

(2, 4) is on the line $x + y = 6$
so it is in the shaded
region, as inequality is
 $x + y \leq 6$ (1)

(Total for Question 13 is 5 marks)

Geoffrey is wrong.



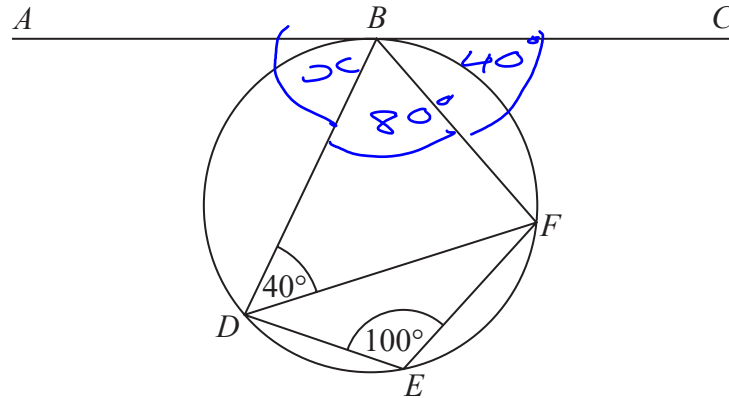

Points B , D , E and F lie on a circle.
 ABC is the tangent to the circle at B .

Find the size of angle ABD .

You must give a reason for each stage of your working.

$$\angle DBF = 80^\circ \text{ (opposite angles in cyclic quadrilateral add to } 180^\circ \text{)}$$

$$\angle CBF = 40^\circ \text{ (alternate segment theorem)}$$

$$\angle ABD = 60^\circ \text{ (angles on straight line add to } 180^\circ \text{)}$$

(Total for Question 14 is 4 marks)



15 Prove algebraically that $0.\dot{7}3$ can be written as $\frac{11}{15}$

$$x = 0.7333 \dots$$

$$10x = 7.333 \dots \quad (1)$$

$$100x = 73.333 \dots \quad (2)$$

$$(2) - (1)$$

$$90x = 66$$

$$x = \frac{66}{90} = \frac{11}{15}$$

(Total for Question 15 is 2 marks)



16 Here is a speed-time graph for a car.

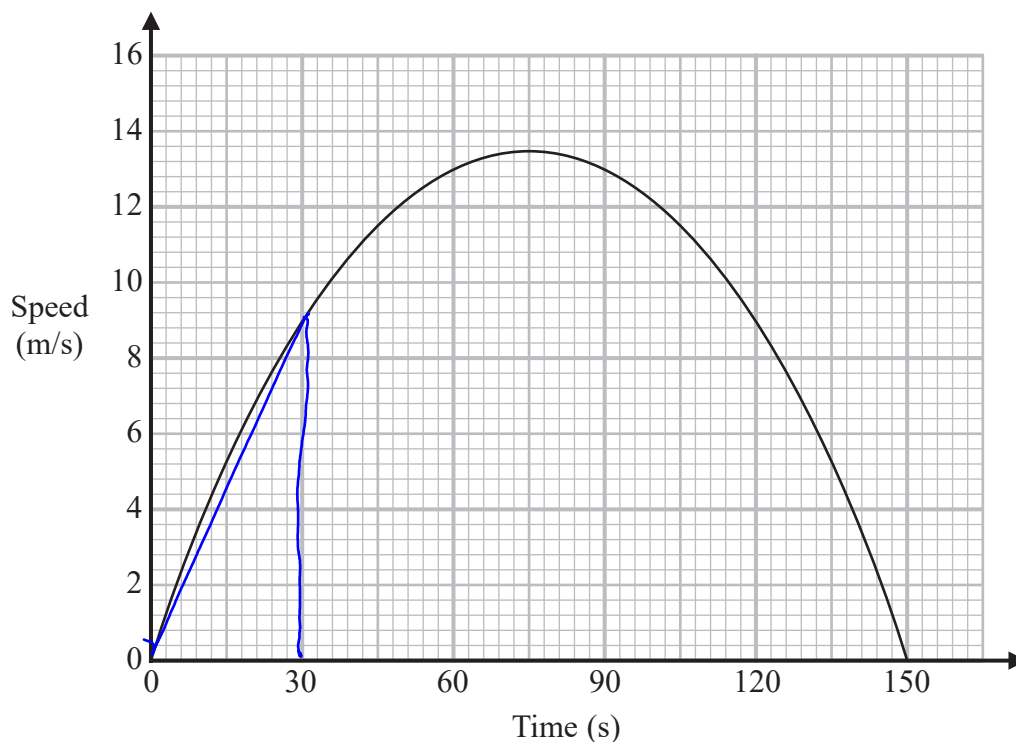

(a) Work out an estimate for the distance the car travelled in the first 30 seconds.

$$\text{Area triangle} = \frac{1}{2} \times 30 \times 9$$

..... 135 m
(2)

(b) Is your answer to part (a) an underestimate or an overestimate of the actual distance the car travelled in the first 30 seconds?

Give a reason for your answer.

Underestimate, as hypotenuse
of triangle is below the
curve.

(1)



Julian used the graph to answer this question.

Work out an estimate for the acceleration of the car at time 60 seconds.

Here is Julian's working.

$$\begin{aligned}\text{acceleration} &= \text{speed} \div \text{time} \\ &= 13 \div 60 \\ &= 0.21\dot{6} \text{ m/s}^2\end{aligned}$$

Julian's method does not give a good estimate of the acceleration at time 60 seconds.

(c) Explain why.

He has not drawn or used a
tangent at time = 60 seconds
to find the gradient

(1)

(Total for Question 16 is 4 marks)

DO NOT WRITE IN THIS AREA



- 17 The histogram gives information about the distances 80 competitors jumped in a long jump competition.

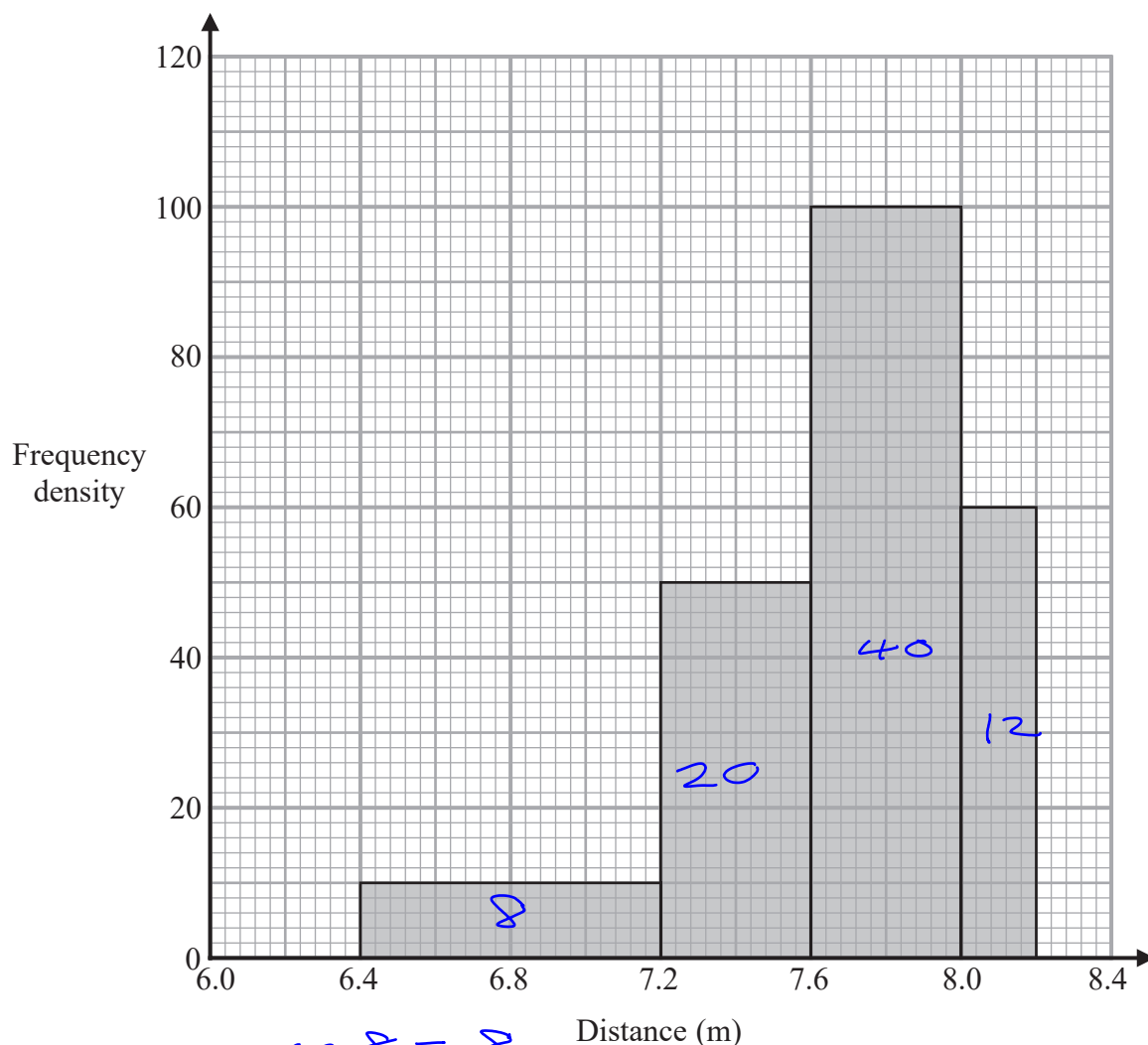

$$10 \times 0.8 = 8$$

Distance (m)

$$50 \times 0.4 = 20$$

Calculate an estimate for the mean distance.

$$100 \times 0.4 = 40$$

$$0.2 \times 60 = 12$$

midpoint

$$f \times xc$$

$$6.4 \leq d < 7.2$$

f

$$8 \times 6.8$$

$$54.4$$

$$7.2 \leq d < 7.6$$

$$20 \times 7.4$$

$$148$$

$$7.6 \leq d < 8$$

$$40 \times 7.8$$

$$312$$

$$8 \leq d < 8.2$$

$$12 \times 8.1$$

$$97.2$$

$$\frac{611.6}{80}$$

$$\frac{611.6}{80}$$

$$\text{Estimated mean} = \frac{611.6}{80} =$$

$$7.645 \text{ m}$$

(Total for Question 17 is 4 marks)



18 The diagram shows a cube.

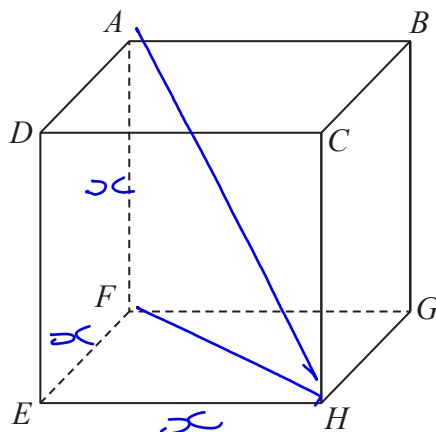

$AH = 11.3$ cm correct to the nearest mm.

Lower bound = 11.25 cm

Calculate the lower bound for the length of an edge of the cube.
You must show all your working.

$$FH = \sqrt{x^2 + x^2} = \sqrt{2x^2}$$

$$FH^2 + AF^2 = 11.25^2$$

$$2x^2 + x^2 = 126.5625$$

$$3x^2 = 126.5625$$

$$x^2 = 42.1875$$

$$x = 6.495190528$$

6.495190528 cm

(Total for Question 18 is 4 marks)



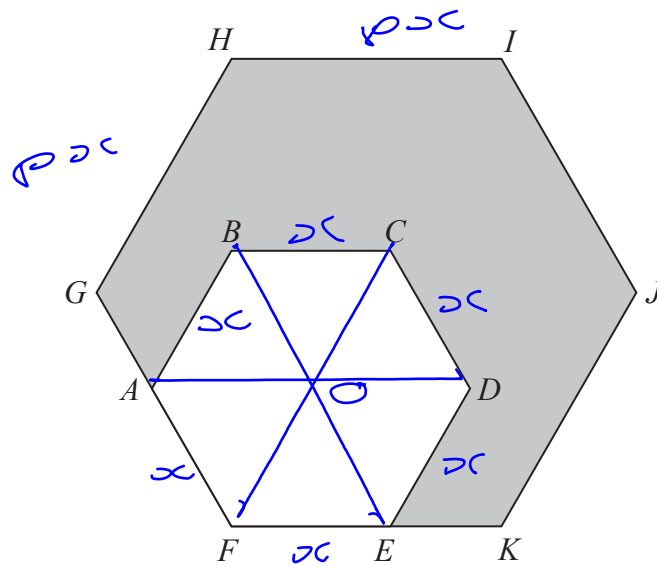

$ABCDEF$ is a regular hexagon with sides of length x .

This hexagon is enlarged, centre O , by scale factor p to give hexagon $FGHIJK$.

Show that the area of the shaded region in the diagram is given by $\frac{3\sqrt{3}}{2}(p^2 - 1)x^2$

$$\begin{aligned} \text{area } \triangle ABO &= \frac{1}{2} \times x \times x \times \sin 60^\circ \\ &= \frac{\sqrt{3}}{4} x^2 \end{aligned}$$

$$\begin{aligned} \text{area white hexagon} &= 6 \times \frac{\sqrt{3}}{4} x^2 \\ &= \frac{3}{2} \sqrt{3} x^2 \quad (1) \end{aligned}$$

large hexagon

area 1 triangle

$$\begin{aligned} &= \frac{1}{2} \times px \times px \times \sin 60^\circ \\ &= \frac{1}{2} \times \frac{\sqrt{3}}{2} \times p^2 x^2 \end{aligned}$$

$$\text{area large hexagon} = \frac{3}{2} \sqrt{3} p^2 x^2 \quad (2)$$

$$\text{Shaded} = (2) - (1)$$

$$\begin{aligned} &= \frac{3}{2} \sqrt{3} p^2 x^2 - \frac{3}{2} \sqrt{3} x^2 \\ &= \frac{3}{2} \sqrt{3} x^2 (p^2 - 1) \end{aligned}$$

(Total for Question 19 is 4 marks)



DO NOT WRITE IN THIS AREA

DO NOT WRITE IN THIS AREA

DO NOT WRITE IN THIS AREA

20 Here is a list of five numbers.

98^{53}

98^{64}

98^{73}

98^{88}

98^{91}

Find the lowest common multiple of these five numbers.

98^{91}

(Total for Question 20 is 1 mark)



P 6 2 2 7 9 A 0 2 3 2 4

21 $5c + d = c + 4d$

(a) Find the ratio $c : d$

$$4c = 3d$$

$$\frac{c}{d} = \frac{3}{4}$$

$$\frac{3}{4}$$

(2)

$6x^2 = 7xy + 20y^2$ where $x > 0$ and $y > 0$

(b) Find the ratio $x : y$

$$6x^2 - 7xy - 20y^2 = 0$$

substitute $x = 1$

$$6 - 7y - 20y^2 = 0$$

$$20y^2 + 7y - 6 = 0$$

$$(5y - 2)(4y + 3) = 0$$

$$y = \frac{2}{5}$$

$$y = -\frac{3}{4}$$

impossible

$$6x^2 - 7x \times \frac{2}{5} - 20 \times \left(\frac{2}{5}\right)^2 = 0$$

$$6x^2 - \frac{14}{5}x - \frac{16}{5} = 0$$

$$30x^2 - 14x - 16 = 0$$

$$15x^2 - 7x - 8 = 0$$

$$(15x + 8)(x - 1) = 0$$

$$\frac{5}{2}$$

$$x = -\frac{8}{15} \quad x = 1$$

impossible

(Total for Question 21 is 5 marks)

$$x : y$$

$$1 : \frac{2}{5}$$

$$5 : 2$$

TOTAL FOR PAPER IS 80 MARKS

